



Tapered Cylinder 24 16

Tapered Cylinders are a family of all-weather planters made from powder-coated marine-grade aluminum.

Green Theory™

greentheorydesign.com

Date: 10 21 2021
Specification Sheet Version 1.1A
Units measured in imperial inches

Green Theory reserves the right to revise technical specifications at any time without prior notice. Correct mounting hardware and the method of mounting of the product are imperative to user safety. Use installation instructions to correctly position and install product.
©2021 Green Theory Design

Tapered Cylinder

24 16

Materials, Finishes & Accessories

5052 Aluminum

Tapered Cylinders are made with Marine Grade 5052 Aluminum

Standard Powder Coat

- Matte Black
- Pewter
- Gloss White
- Metallic Silver
- Smokey Beige
- Suede Bronze
- Matte Clear

Premium Powder Coat

- Obsidian
- Sandstone
- Desert
- Terra
- Dark Oak
- Smoke

Additional Finishing

- No Drainage
- Anchor Points
- No Top Lip

Custom Powder Coat

RAL _____

Notes

Quantity

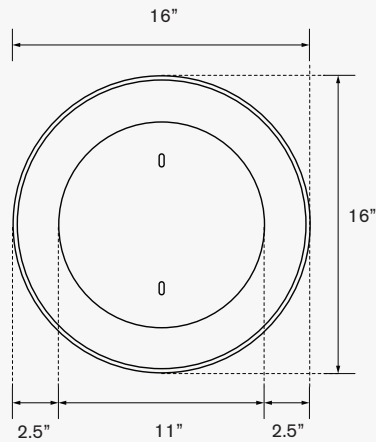
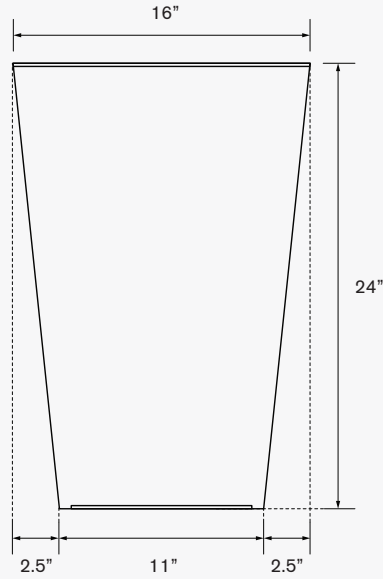

Green Theory™

greentheorydesign.com

Date: 10 21 2021
Specification Sheet Version 1.1A
Units measured in imperial inches

Green Theory reserves the right to revise technical specifications at any time without prior notice. Correct mounting hardware and the method of mounting of the product are imperative to user safety. Use installation instructions to correctly position and install product.
©2021 Green Theory Design